

Agenda Item # 20
Date 3/11/20

March 11, 2020

Fremont Tribune
Classified Section
Box 9
Fremont, NE 68026

Good Day!

Please publish the following legal ad one time between March 11 – March 17, 2020.

NOTICE OF PUBLIC HEARING

Notice is hereby given that the Dodge County Board of Supervisors will conduct a Public Hearing on Wednesday, March 25, 2020 at 9:15 A.M. in the Board Room of the Courthouse, 3rd floor, 4th and Park, Fremont, Nebraska, to consider the application for a Class Z Micro Distillery Liquor License for Huffman Prairie Ventures LLC, dba Flyover Whiskey, for a distilled spirit plant located at 1614 County Road 4, North Bend, Nebraska, Dodge County. All persons desiring to give evidence before the local governing body in support of or protest against the issuance of such license may do so at the time of the hearing.

Fred Mytty
Dodge County Clerk



Pete Ricketts
Governor

RECEIVED

2020 MAR -4 PM 3: 23

DODGE COUNTY, NEBRASKA
FRED MYTTY, COUNTY CLERK

STATE OF NEBRASKA

NEBRASKA LIQUOR CONTROL COMMISSION

Hobert B. Rupe

Executive Director

301 Centennial Mall South, 5th Floor

P.O. Box 95046

Lincoln, Nebraska, 68509-5046

Phone (402) 471-2571

Fax (402) 471-2814 or (402) 471-2374

TSR USER 800-833-7252 (TTY)

Web Address <http://www.lcc.nebraska.gov/>

March 4, 2020

Dodge County Clerk
435 N Park Ave
Fremont, NE 68025

RE: Liquor license Class Z-123581 for Flyover Whiskey

Clerk:

Attached is the form to be used on all retail liquor license applications. Local clerks must collect proper license fees and occupation tax per ordinance, if any, before delivering the license at time of issuance.

TWO KEY TIME FRAMES TO KEEP IN MIND ARE:

- 1) Publicize one time not less than 7 days not more than 14 days prior to date of hearing.
- 2) You have 45 days to conduct a hearing after the date of receipt of the notice from this Commission (§53-134). You may choose **NOT** to make a recommendation of approval or denial to our Commission.

PER §53-133, THE LIQUOR CONTROL COMMISSION SHALL SET FOR HEARING ANY APPLICATION WHEREIN:

- 1) There is a recommendation of denial from the local governing body.
- 2) A citizens protest; or
- 3) Statutory problems that the Commission discovers.

PLEASE NOTE...A LICENSEE MUST BE PROPERLY LICENSED IN ORDER TO PURCHASE FROM WHOLESALERS; AND, A LICENSE IS EFFECTIVE:

- 1) Upon payment of the license fees;
- 2) Physical possession of the license;
- 3) Effective date on the license.

Sincerely,

Brenda Hiland
Licensing Division
Nebraska Liquor Control Commission

Enclosures

Janice M. Wiebusch
Commissioner

Bruce Bailey
Chairman

Harry Hoch
Commissioner

An Equal Opportunity Employer

RECEIPT

From: Brenda Hiland
Phone #: 402-471-2735
Fax #: 402-471-2814
Company Name: Nebraska Liquor Control Commission

To: Dodge County Clerk
Re: Huffman Prairie Ventures LLC
DBA: Flyover Whiskey
Application #: Z-123581

PLEASE COMPLETE THE BOTTOM SECTION IMMEDIATELY UPON RECEIPT OF THIS APPLICATION AND FAX OR EMAIL THIS FORM BACK ACKNOWLEDGING THE RECEIPT OF THIS APPLICATION. PLEASE DATE STAMP IF THAT OPTION IS AVAILABLE. THANK YOU.

DATE OF RECEIPT

SIGNATURE

RECOMMENDATION OF THE NEBRASKA LIQUOR CONTROL COMMISSION

Date Mailed from Commission Office: March 4, 2020

I, _____ Clerk of _____
(City, Village or County)

Nebraska, hereby report to the Nebraska Liquor Control Commission in accordance with Revised Statutes of Nebraska, Chapter 53, Sec. 134 (7) the recommendation of said city, village or county, as the case may be relative to the application for a license under the provisions of the Nebraska Liquor Control Act as applied for by:

Huffman Prairie Ventures LLC dba Flyover Whiskey
1614 County Road 4, North Bend / Dodge County, 68649
Application for Class Z - 123581
45 days - 4/20/2020

- 1. Notice of local hearing was published in a legal newspaper in or of general circulation in city, village or county, one time not less than 7 nor more than 14 days before time of hearing.

Check one Yes _____ No _____

The Statutes require that such hearing shall be held not more than 45 days after the date of receipt of this notice from the Commission.

- 2. Local hearing was held not more that 45 days after receipt of notice from the Nebraska Liquor Control Commission.

Check one Yes _____ No _____

- 3. Date of hearing of Governing Body: _____

- 4. Type or write the Motion as voted upon by the Governing Body. If additional Motions are made by the Governing Body, then use an additional page and follow same format.

- 5. Motion was made by: _____ Seconded by: _____

- 6. Roll Call Vote: _____

Check one: The motion passed: _____ The motion failed: _____

- 8. If the motion is for recommendation of denial of the applicant, then list the reasons of the governing body upon which the motion was made.

(Attached additional page if necessary)

SIGN HERE _____ DATE _____
clerks signature

**APPLICATION FOR LIQUOR LICENSE
MICRODISTILLERY CHECKLIST**

NEBRASKA LIQUOR CONTROL COMMISSION
301 CENTENNIAL MALL SOUTH
PO BOX 95046
LINCOLN, NE 68509-5046
PHONE: (402) 471-2571
FAX: (402) 471-2814
Website: www.lcc.nebraska.gov

RECEIVED
NEBRASKA LIQUOR
CONTROL COMMISSION

NEBRASKA LIQUOR CONTROL COMMISSION

NEBRASKA LIQUOR CONTROL COMMISSION	
FEB 26 2020	
RECEIVED	
Hot List Yes <input checked="" type="checkbox"/> No <input type="checkbox"/>	New Replacing #:
Class Type Z	LI 123581
	Initials JH

Applicant Name Andrew Minarick - Huffman Prairie Ventures LLC

Trade Name Flyover Whiskey

E-Mail Address: andrew.minarick@gmail.com

Web Site Address: flyoverwhiskey.com (Not active yet)

Provide all the items requested. Failure to provide any item will cause this application to be returned or placed on hold. All documents must be legible. Any false statement or omission may result in the denial, suspension, cancellation or revocation of your license. If your operation depends on receiving a liquor license, the Nebraska Liquor Control Commission cautions you that if you purchase, remodel, start construction, spend or commit money that you do so at your own risk. Prior to submitting your application review the application carefully to ensure that all sections are complete, and that any omissions or errors have not been made. You may want to check with the city/village or county clerk, where you are making application, to see if any additional requirements must be met before submitting application to the state. You must first have made application with Alcohol and Tobacco Tax and Trade Bureau (TTB).

REQUIRED ATTACHMENTS

Microdistillery means a distillery located in Nebraska that is licensed to distill liquor on the premises of the distillery licensee and produces ten thousand or fewer gallons of liquor annually.

- _____ 1) Application fee \$400 plus licensee fee \$250
Total \$650 (Check made payable to Nebraska Liquor Control Commission) or pay online at PAYPORT
- (A) _____ 2) Copy of Federal Basic Permit application as filed with Alcohol and Tobacco Tax and Trade Bureau (TTB)
- (B) _____ 3) Alcoholic Liquor Tax Bond, \$1,000 minimum including the Power of Attorney documentation
(May use FORM 115)

** Lease*

OFFICE USE ONLY
 PAYMENT TYPE: CK # 98
 AMOUNT: \$650.00
 RECEIVED BY: BJ
 RECEIPT #: 170002

226- Misc Dep



2000002395

RECEIVED

RECEIPT

DATE 2-26-20 No. 170002

FROM Huffman Law Firm - Ventura

FOR Huffman Law Firm LLC



CASH
 CHECK # 98
 MONEY# _____
ORDER

\$ 1050.00

Received by [Signature]

RECEIVED

- (c) _____ 4) Submit diagram to include:
a. Facility dimensions and description
b. Identify production area
c. Any storage area
- (d) _____ 5) Copy of your detailed business plan
- (e) _____ 6) Fingerprints are required for each person as defined in new application guideline. See FORM 147 for further information, this form **MUST** be included with your application
- (f) _____ 7) Enclose the appropriate application forms
Individual License (requires insert 1- FORM 104)
Partnership License (requires insert 2 - FORM 105)
Corporate License (requires insert 3A - FORM 101 & 3C FORM 103)
Limited Liability Company (LLC) (requires insert 3B - FORM 102 & 3C FORM 103)
- (g) _____ 8) If building is being leased send a copy of signed lease. Be sure the lease reads in the name of the individual(s), corporation or Limited Liability Company making application. Lease term must run through the license year being applied for.
- (h) _____ 9) Corporation or Limited Liability Company must enclose a copy of articles of incorporation; as filed with the Secretary of State's Office.

I acknowledge that this application is not a guarantee that a liquor license will be issued to me, and that the average processing period is 60 days. Furthermore, I understand that all the information is truthful and I accept all responsibility for any false documents.



Authorized Signature

Andrew Minarick

Print Name

(402) 720-6972

Contact Phone Number

2/26/20

Date

ALCOHOLIC LIQUOR TAX BOND

Effective Date: February 18th, 2020

NEBRASKA LIQUOR CONTROL COMMISSION
301 CENTENNIAL MALL SOUTH
PO BOX 95046
LINCOLN, NE 68509-5046
PHONE: (402) 471-2571
FAX: (402) 471-2814
Website: www.lcc.nebraska.gov

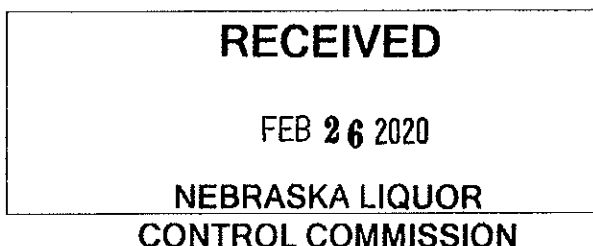

KNOW ALL MEN BY THESE PRESENTS:

That we, Huffman Prairie Ventures, LLC DBA Flyover Whiskey of the County of Dodge, State of Nebraska as Principal of WESTERN SURETY COMPANY, and duly licensed to transact the business of surety insurance in the State of Nebraska, as Surety, are held and firmly bound unto the State of Nebraska, and the City (Village) of North Bend in Dodge County, Nebraska, and the Nebraska Liquor Control Commission and each of them jointly or severally, in the penal sum of One Thousand and 00/100 DOLLARS (\$ 1,000.00) for the payment of which, we bind ourselves, our heirs, executors, administrators, successors and assigns, jointly, severally and firmly by these presents.

The condition of this obligation is such that,

WHEREAS, the said Huffman Prairie Ventures, LLC DBA Flyover Whiskey has made application under the Nebraska Liquor Control Commission Act for the following license(s) check each that apply:

- Class L-Craft Brewery
Class W-Wholesale Beer
Class V-Manufacturer (beer, wine, spirits)
Class Y-Farm Winery
Class X-Wholesale Liquor
[X] Class Z-Micro Distillery

NOW, THEREFORE, upon application for such license and continuing after the issuance of the same to the said principal above named, if the said principal hereinabove named shall faithfully perform all the terms and conditions of said license(s), and shall promptly account for and pay to the proper authorities all lawful taxes, fees, assessments that have accrued during the term of said license or licenses, and all fines, penalties and costs which shall become due from or shall be levied, charges or adjudged against said principal on account of defaults occurring during the entire effective period of this bond, under the provisions of said Act by said Commission, or any court or other lawful authority; and shall truly and faithfully comply as such licensee with all of the provisions of said Act of the Legislature and all future Nebraska Liquor Control laws which may be enacted during the term of such license or licenses, and shall truly and faithfully comply with all lawful rules and regulations of said Commission, and said City (Village) during the term of said license or licenses, then this obligation shall be null and void.

OTHERWISE, to be and remain in full force and effect;

This Bond shall run concurrently with the term of said license or licenses granted to the principal, and shall remain in full force and effect for any renewal thereof, provided, however, that the penalty of the Bond may not be cumulative from year to year, and the total aggregate liability of the surety shall not exceed \$ 1,000.00, regardless of the number of claims made under this Bond and the number of years this Bond remain in effect.

The surety may cancel this Bond by providing 60 days prior written notice of such cancellation to the Nebraska Liquor Control Commission, but the surety providing such notice shall not be discharged from any liability already accrued under this Bond or which shall accrue under this Bond before expiration of said 60 day period. Upon cancellation of this Bond, the surety shall be relieved of liability accruing after the effective date of cancellation, and the rights of the principal under such license, as is supported by said Bond, shall be cancelled and terminated on the date specified, unless the principal provides a sufficient replacement Bond.

This Bond shall be effective during all proceedings involving the application for license under the Nebraska Liquor Control Act for Alcoholic Liquor and/or Beer license and upon issuance of said license this Bond shall continue until cancelled as set forth hereinabove.

This Bond has been given Bond number 64982172

PRINCIPAL

SURETY COMPANY

IN TESTIMONY, WHEREOF, said PRINCIPAL has hereunto subscribed his or their names or has caused this instrument to be signed by its duly authorized officer this date: 2/26/20 A.D.

IN TESTIMONY, WHEREOF, said SURETY has caused this instrument to be signed by its duly authorized office and its corporate seal to be hereunto affixed this date: February, 2020 A.D. 2020

[Handwritten Signature]
SIGNATURE

[Handwritten Signature]
SIGNATURE for Attorney-in-Fact for Surety Company

Andrew M. Narick
PRINT NAME HERE

Paul T. Bruflat, Vice President
PRINT NAME HERE

WITNESS SIGNATURE

WESTERN SURETY COMPANY
SURETY COMPANY NAME

PRINT NAME HERE

P. O. Box 5077, Sioux Falls, SD 57117-5077
SURETY COMPANY MAILING ADDRESS

(605) 336-0850

SURETY COMPANY AREA CODE AND PHONE NUMBER

(573) 445-3425

INSURANCE PRODUCER'S AREA CODE AND PHONE NUMBER

NOTICE

Bond will not be accepted unless properly signed by applicant, whose signature shall be witnessed. It is also necessary that all Bonds be signed by an official or agent of the Bonding Company who holds and unexpired power-of-attorney from the Bonding Company and unexpired Nebraska liquor license as insurance producer for said company. An additional requirement is attachment of the seal of the Bonding Company and, if applicant is a corporation, their seal should also be attached.

Western Surety Company

POWER OF ATTORNEY

KNOW ALL MEN BY THESE PRESENTS:

That WESTERN SURETY COMPANY, a corporation organized and existing under the laws of the State of South Dakota, and authorized and licensed to do business in the States of Alabama, Alaska, Arizona, Arkansas, California, Colorado, Connecticut, Delaware, District of Columbia, Florida, Georgia, Hawaii, Idaho, Illinois, Indiana, Iowa, Kansas, Kentucky, Louisiana, Maine, Maryland, Massachusetts, Michigan, Minnesota, Mississippi, Missouri, Montana, Nebraska, Nevada, New Hampshire, New Jersey, New Mexico, New York, North Carolina, North Dakota, Ohio, Oklahoma, Oregon, Pennsylvania, Rhode Island, South Carolina, South Dakota, Tennessee, Texas, Utah, Vermont, Virginia, Washington, West Virginia, Wisconsin, Wyoming, and the United States of America, does hereby make, constitute and appoint

Paul T. Bruflat of Sioux Falls,
State of South Dakota, its regularly elected Vice President,
as Attorney-in-Fact, with full power and authority hereby conferred upon him to sign, execute, acknowledge and deliver for and on its behalf as Surety and as its act and deed, the following bond:

One Micro Distillery

bond with bond number 64982172

for Huffman Prairie Ventures, LLC DBA Flyover Whiskey

as Principal in the penalty amount not to exceed: \$ 1,000.00

Western Surety Company further certifies that the following is a true and exact copy of Section 7 of the by-laws of Western Surety Company duly adopted and now in force, to-wit:

Section 7. All bonds, policies, undertakings, Powers of Attorney, or other obligations of the corporation shall be executed in the corporate name of the Company by the President, Secretary, any Assistant Secretary, Treasurer, or any Vice President, or by such other officers as the Board of Directors may authorize. The President, any Vice President, Secretary, any Assistant Secretary, or the Treasurer may appoint Attorneys-in-Fact or agents who shall have authority to issue bonds, policies, or undertakings in the name of the Company. The corporate seal is not necessary for the validity of any bonds, policies, undertakings, Powers of Attorney or other obligations of the corporation. The signature of any such officer and the corporate seal may be printed by facsimile.

In Witness Whereof, the said WESTERN SURETY COMPANY has caused these presents to be executed by its Vice President with the corporate seal affixed this 18th day of February, 2020.

ATTEST

L. Nelson

L. Nelson, Assistant Secretary

WESTERN SURETY COMPANY

By

Paul T. Bruflat

Paul T. Bruflat, Vice President

STATE OF SOUTH DAKOTA }
COUNTY OF MINNEHAHA } ss



On this 18th day of February, 2020, before me, a Notary Public, personally appeared Paul T. Bruflat and L. Nelson who, being by me duly sworn, acknowledged that they signed the above Power of Attorney as Vice President and Assistant Secretary, respectively, of the said WESTERN SURETY COMPANY, and acknowledged said instrument to be the voluntary act and deed of said Corporation.

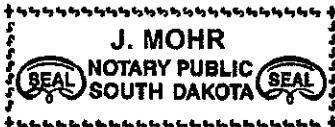

My Commission Expires June 23, 2021

J. Mohr

Notary Public

To validate bond authenticity, go to www.cnasurety.com > Owner/Obligee Services > Validate Bond Coverage.



Industry Member Information

Report Date: 2/13/2020 6:11:06PM

Original Application 02/13/2020
Submitted Date

Original Application Tracking Number 2020-DSPBI-00084-O
Application Type Application for Distilled Spirit Plant (Beverage and Industrial)
Application Status Review in Process
EIN 84-4119883
Company Name Huffman Prairie Ventures, LLC
Premises Address 1614 COUNTY ROAD 4
NORTH BEND, NE 68649
Premise Contact Name
Premise Phone Number

Application Contact

Full Name Andrew Minarick
Business Name
Address/City/State/Zip 1361 County Road 4
North Bend NE 68649
Phone/Fax 402-720-6972/--
Email andrew.minarick@gmail.com

Mailing Address

Full Name Andrew Minarick
Business Name
Address/City/State/Zip 1361 County Road 4
North Bend NE 68649
Phone/Fax 402-720-6972/--
Email andrew.minarick@gmail.com

DBA/OPERATING NAME

Doing Business As / Operating Name Flyover Whiskey

By checking this box I certify that the Doing Business As / Operating Name listed above has been registered with my county or state, if applicable CHECKED

DECLARE AND ACKNOWLEDGE

I declare under penalties of perjury under the laws of the United States of America, that I have examined this application, including accompanying statements, and to the best of my knowledge and belief, it is true, correct, and complete.

CHECKED

Declaration Date

02/13/2020

DSP BEVERAGE OPERATION INFO

Distiller

CHECKED

Warehouseman

CHECKED

Processor (Bottling)

CHECKED

Provide the total proof gallons of spirits that can be produced daily

12.8

Describe the step by step production procedure used to produce spirits from an original source. Begin with the treating, mashing, or fermenting of the raw materials and continue through each step of the distilling, purifying and refining process, until production is complete

Our operation will source corn directly from farmers, with sugar and yeast procured from wholesalers. The corn will be washed and sanitized using a hot water bath and then cooked in a separate warm water solution to break down starches and prepare for fermentation. The solution will be separated from any unwanted residue and mixed with sugar and yeast. The solution will be added to sanitized 5 gallon plastic buckets with airtight seals, with an airlock installed to facilitate the anaerobic fermentation process (approximately 5-14 days). Once the fermentation process is over, the solution will be strained and transferred to an 8 gallon, stainless-steel still. Using a column still and condenser, the liquid will be heated from 140-160 degrees Fahrenheit until a low boiling point distillate foreshot (i.e. methanol) is removed. The temperature will then be raised to 173 degree. From the 173-185 degree range we will make our 'head' cut. As our temperature is raised to 205 degrees, we will make subsequent cuts, all at approximately 80% alcohol by volume. Once we have collected each cut (measured using graduated flask) and are finished with our distillation process we will then dilute the cuts to 40% alcohol by volume, measuring alcohol content with a hydrometer, and storing solution in sanitized storage containers. We will then begin the aging process with charred oak. Once the aging process is completed, we will then measure alcohol content to maintain 40% alcohol content and strain the aged whiskey into 750mL glass bottles. We will ensure proper labeling, and send out to be shipped direct to consumer (in Nebraska

Describe how bulk spirits will be stored

Bulk spirits will immediately be diluted to 40% alcohol by volume and transferred to containers to be aged using charred oak. These containers will be stored in a locked container on the bonded premises. Once the aging process is done, the solution will be transferred to approved shipping containers, labeled, and prepared for shipping immediately. All of these bottles will be and locked on the bonded premises until shipped. Due to the low volume of each customer's order and quick shipments, we do not realistically expect to store more than 20 proof gallons at a time.

Provide the bulk storage capacity (in gallons)

40

Describe the storage system for spirits bottled and cased or otherwise packaged and placed in approved containers for removal from bonded premises

Once spirits are transferred to bottles, the bottles will be sealed, labeled, and placed in proper shipping boxes. These boxes will be labeled and stored in a locked storage shelf on the bonded premises until removed for shipping.

Will spirits be redistilled?

No

DSP INFORMATION

Describe each tract of land that makes up the distillery by using directions and distances. Please describe the land only

Head West of North Bend, NE, North 4 miles off Highway 30 onto County Road 4. Legal Description of Land: TL 1 3.68A 22 18 5 (NW1/4NW1/4), Parcel ID 270136340, as Registered with Dodge County Assessor. Starting at SW corner of land, head 205' North, 250' East to SW corner of general premises (entire building).

Provide the dimensions (size) of the bonded premises

The area of bonded premises is 16' x 8' (approximately 128 square feet). From the SW corner of General premises, head 25' North and 9' East to NW corner of bonded Premises. Then head 16' East to NE corner of bonded premises. Head 8' South to SE corner of bonded premises. Head 16' West to SW corner of bonded premises. Then Head 8' North back to the NW corner of bonded Premises. NOTE: The bonded premises is a partitioned section of the General Premises building.

Describe the construction of each building that is part of the bonded premises

General Premises: Cement Foundation, Wood Framed, Tin siding and roofing. Overhead door with lock and regular door with lock.

Bonded Premises: Cement Foundation, Wood Framed, Tin exterior siding with food grade wall paneling on interior, entrance door with lock.

Describe the operations conducted in each building that is part of the bonded premises

The bonded premises is composed of a single building and will be used for Mashing, Distilling, Aging, Storage, and Packaging of distilled spirits.

List the location of each door and window for the buildings that are part of the bonded premises

General Premises: Both the main entrance and roll-up door are on the West side of the building facing the road. There are no windows.

Bonded Premises: General entrance door is on the West side of the bonded premises. Located for bonded premises directly East of the main entrance door of the General Premises (see diagram).

If only part of the building is being used for DSP operations, list and describe each floor/room(s) that are part of the bonded premises and the operations being conducted. Enter N/A if the entire building is being used for the DSP operations

The Bonded Premises will be used for the DSP operations. The rest of the General Premises will be used for storage of things such as renovation materials/tools, packaging cardboard and dunnage, and spare materials needed for general repair or replacement.

List any outside tanks that will be used for production, storage and processing of spirits, and/or for denaturing spirits, articles, or wine

N/A (Operation is small enough to all fit within bonded premises).

Describe the general premises which includes all areas of the plant that are not covered under the bond

The General Premises is a 25'x25' general purpose building with an overhead door and a main entrance door. The DSP licensee, Andrew Minarick, will have sole access to this building.

Will you be alternating?

No

Provide the maximum combined number of proof gallons that will be produced, stored, and in transit to the bonded premises during a 15 day period	75
I certify that I AM NOT required to provide a bond	CHECKED
Describe the plant security, including methods used to secure buildings or plant operations located within a portion of the building and any outdoor tanks	The entrances of the general premises and bonded premise will remain locked at all times (steel doors with locks). Aging whiskey and bottled whiskey will be in locked storage shelves within the bonded premises. There are no windows other entrances to the building.
Will any guard personnel be employed?	No
Will any electronic or mechanical alarm system be used?	No
I certify that locks used will meet the following specifications as required in the Code of Federal Regulations, Part, 19.192 (f). (i) Corresponding serial number on the lock and on the key, except for master key locking systems; (ii) Case hardened shackle at least one-fourth inch in diameter, with heel and toe locking; (iii) Body width of at least 2 inches; (iv) Captured key feature (key may not be removed while shackle is unlocked); (v) A tumbler with at least 5 pins; and (vi) A lock and key containing no biting data	CHECKED
List all persons, by their position and title, who have access to the keys for the locks	Andrew Minarick, Owner - Huffman Prairie Ventures, LLC
By checking this box I certify that accounting records for this distilled spirits plant will be maintained in accordance with generally accepted accounting principles	CHECKED
Describe any other business that will be conducted on the premises. Please include a description of the business, a list of buildings and/or equipment that will be used, and a statement of the relationship of the business to the distilled spirits plant, if there is any	N/A
Will you have a tasting room?	No
Will you have a retail store?	No
<u>DSP OPERATION TYPE</u>	
Select the type of Distilled Spirits Plant (DSP) operation(s) you are applying for	Beverage Only
<u>ENTITY INFORMATION</u>	
Business Name	Huffman Prairie Ventures, LLC
EIN	84-4119883
Triage Status	No
<u>OWNER BACKGROUND INFORMATION</u>	

Has any shareholder with more than 10% voting stock, sole owner, general partner, LLC member/manager, or corporate officer or director ever been denied a permit, license, or other authorization to engage in any business to manufacture, distribute, import, sell, or use alcohol products (beverage or non-beverage) by any government agency (federal, state, local, or foreign) or had such a permit, license, or other authorization revoked, suspended, or otherwise terminated? No

Has any shareholder with more than 10% voting stock, sole owner, general partner, LLC member/manager, or corporate officer or director ever been arrested for, charged with, or convicted of any crime under federal, state, or foreign laws other than traffic violations or convictions that are not felonies under federal or state law? No

REASON FOR THE APPLICATION

New distilled spirits plant CHECKED

DSP EQUIPMENT

Select type of Equipment	Still
Serial Number	1001
Capacity	12.8
Kind of Still	Column Still
Intended Use	Still - Distillation
Select type of Equipment	Condenser
Serial Number	2001
Select type of Equipment	Tank
Serial Number	3001
Capacity	6.4
Intended Use	Tank - Production

REQUIRED DOCUMENT CHECKLIST

Document Type	Diagram
Method of Submission	Uploaded
Document Received	undefined
Document Type	Lease Agreement or Proof of Property Ownership
Method of Submission	Uploaded
Document Received	undefined

**APPLICATION FOR LIQUOR LICENSE
MICRODISTILLERY**

301 CENTENNIAL MALL SOUTH
PO BOX 95046
LINCOLN, NE 68509-5046
PHONE: (402) 471-2571
FAX: (402) 471-2814
Website: www.lcc.nebraska.gov/

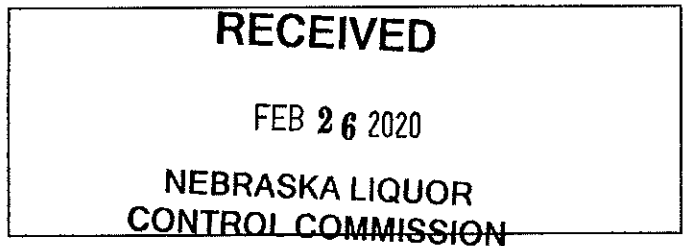

**CLASS OF LICENSE FOR WHICH APPLICATION IS MADE AND FEES
CHECK DESIRED CLASS(S)**

- Class Z Microdistillery Application fee \$400 plus licensee fee \$250
Total \$650 (Check made payable to Nebraska Liquor Control Commission)
- Class K Catering license (requires catering application FORM 106) \$100.00
- Copy of application filed with TTB for Federal Basic Permit
- Alcoholic Liquor Tax Bond minimum of \$1,000 FORM 115

Additional fees may be assessed at city/village or county level when license is issued

Term of license runs from May 1 – April 30

CHECK TYPE OF LICENSE FOR WHICH YOU ARE APPLYING

- Individual License (requires insert 1- FORM 104)
- Partnership License (requires insert 2 – FORM 105)
- Corporate License (requires insert 3A – FORM 101 & 3C FORM 103)
- Limited Liability Company (LLC) (requires insert 3B – FORM 102 & 3C FORM 103)

NAME OF ATTORNEY OR FIRM ASSISTING WITH APPLICATION (if applicable)

Commission will call this person with any questions we may have on this application

Name N/A Phone number: N/A

Firm Name N/A

PREMISE INFORMATION

Trade Name (doing business as) Flyover Whiskey

Street Address #1 1614 County Road 4

Street Address #2 _____

City North Bend County Dodge Zip Code 68649

Premise Telephone number (402) 720-6972

Is this location inside the city/village corporate limits: YES NO

Mailing address (where you want to receive mail from the Commission)

Name Andrew Minarick

Street Address #1 1361 County Road 4

Street Address #2 _____

City North Bend State NE Zip Code 68649

DESCRIPTION AND DIAGRAM OF THE STRUCTURE TO BE LICENSED

READ CAREFULLY

In the space provided or on an attachment draw the area to be licensed. This should include storage areas, basement, and/or sales areas and any area where consumption of alcohol will take place. If only a portion of the building is to be covered by the license, you must still include dimensions (length x width) of the licensed area as well as the dimensions of the entire building. No blue prints please. Be sure to indicate the direction north and **number of floors** of the building. For on premise consumption liquor licenses a minimum standard of at least two restrooms is required.

Building: length 16' x width 8' in feet (Premises) Whole Building: 25' length x 25' width
Is there a basement? Yes _____ No X If yes, length _____ x width _____ in feet
Is there an outdoor area? Yes _____ No X If yes, length _____ x width _____ in feet

PROVIDE DIAGRAM OF AREA TO BE LICENSED BELOW OR ATTACH SEPARATE SHEET

See Attachment C

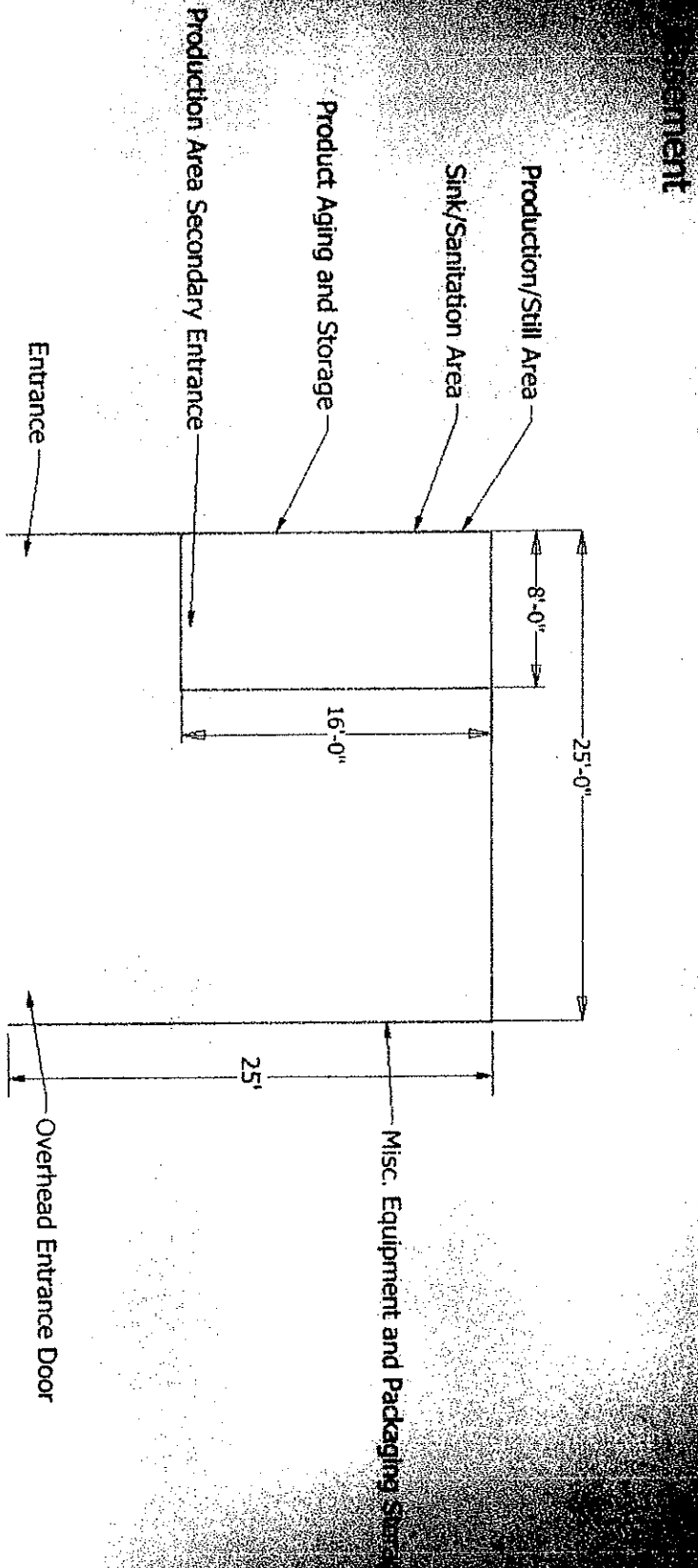

APPLICANT INFORMATION

1. READ CAREFULLY. ANSWER COMPLETELY AND ACCURATELY.

Has anyone who is a party to this application, or their spouse, **[REDACTED]** been convicted of or plead guilty to any charge. Charge means any charge alleging a felony, misdemeanor, violation of a federal or state law; a violation of a local law, ordinance or resolution. List the nature of the charge, where the charge occurred and the year and month of the conviction or plea. Also, list any charges pending at the time of this application. If more than one party, please list charges by each individual's name. **[REDACTED]**. Commission must be notified of any arrests and/or convictions that may occur after the date of signing this application.

YES NO

If yes, please explain below or attach a separate page.

Name of Applicant	Date of Conviction (mm/yyyy)	Where Convicted (city & state)	Description of Charge	Disposition

2. Are you buying the business of a current retail liquor license?

YES NO

If yes, give name of business and liquor license number _____

- a) Submit a copy of the sales agreement
- b) Include a list of alcohol being purchased, list the name brand, container size and how many
- c) Submit a list of the furniture, fixtures and equipment

3. Was this premise licensed as a liquor licensed business within the last two (2) years?

YES NO

If yes, give name and license number _____

4. Are you filing a temporary operating permit to operate during the application process?

YES NO

If yes:

- a) Attach temporary operating permit FORM 125
- b) T.O.P. will only be accepted at a location that currently holds a valid liquor license.

5. Are you borrowing any money from any source, include family or friends, to establish and/or operate the business?

YES NO

If yes, list the lender _____

6. Will any person or entity, other than applicant, be entitled to a share of the profits of this business?

YES NO

If yes, explain. (All involved persons must be disclosed on application)

No silent partners

7. Will any of the furniture, fixtures and equipment to be used in this business be owned by others?

YES NO

If yes, list such item(s) and the owner. _____

8. Is premise to be licensed within 150 feet of a church, school, hospital, home for the aged or indigent persons or for veterans, their wives, and children, or within 300 feet of a college or university campus?

YES NO

If yes, provide name and address of such institution and where it is located in relation to the premises (Neb. Rev. Stat. 53-177) _____

9. Is anyone listed on this application a law enforcement officer?

YES NO

If yes, list the person, the law enforcement agency involved and the person's exact duties

10. List the primary bank and/or financial institution (branch if applicable) to be utilized by the business

a) List the individual(s) who will be authorized to write checks and/or withdrawals on accounts at this institution.

Chase Bank (144 N 14th St. Lincoln, NE) - Authorized Individuals: Andrew Minarick

11. List all past and present liquor licenses held in Nebraska or any other state by any person named in this application. Include license holder name, location of license and license number. Also list reason for termination of any license(s) previously held.

N/A

12. List the alcohol related training and/or experience (when and where) of the person(s) making application. Those persons required are listed as followed:

- Individual: Applicant and spouse; spouse is exempt if they filed Form 116 – Affidavit of Non-Participation.
- Partnership: All partners and spouses, spouses are exempt if they filed Form 116 – Affidavit of Non-Participation.
- Limited Liability Company: All member of LLC, Manager and all spouses; spouses are exempt if they filed Form 116 – Affidavit of Non-Participation.
- Corporation: President, Stockholders holding 25% or more of shares, Manager and all spouses; spouses are exempt if they filed Form 116 – Affidavit of Non-Participation.

NLCC certified training program completed:

Applicant Name	Date (mm/yyyy)	Name of program (attach copy of course completion certificate)

List of NLCC certified training programs
Experience:

Applicant Name/Job Title	Date of Employment:	Name & Location of Business
Andrew Minarick - Engineering Student	2014-2018	University of Nebraska-Lincoln (Lincoln, NE)
Andrew Minarick - Head of Product Development	2015-2019	FarmAfield (Lincoln, NE)
Andrew Minarick - Process Engineer	2019	Parker Hannifin (Lewisburg, OH)

13. If the property for which this license is sought is owned, submit a copy of the deed, or proof of ownership. If leased, submit a copy of the lease covering the entire license year. **Documents must show title or lease held in name of applicant as owner or lessee in the individual(s) or corporate name for which the application is being filed.**

Lease: expiration date December 2020 (with agreement to renew)
 Deed
 Purchase Agreement

4/15/2030
4/15/2020

14. When do you intend to open for business? 4/15/2020

15. What will be the main nature of business? Distillation and Direct to Consumer Whiskey

16. What are the anticipated hours of operation? Saturdays: 8AM - 6 PM

17. List the principal residence(s) for the past 10 years for all persons required to sign, including spouses.

RESIDENCES FOR THE PAST 10 YEARS, APPLICANT AND SPOUSE MUST COMPLETE					
APPLICANT: CITY & STATE	YEAR		SPOUSE: CITY & STATE	YEAR	
	FROM	TO		FROM	TO
North Bend, NE	1995	2014			
Lincoln, NE	2014	2019			
Dayton, OH	2019	2019			
North Bend, NE	2019	Present			

If necessary attach a separate sheet.

The undersigned applicant(s) hereby consent(s) to an investigation of his/her background and release present and future records of every kind and description including police records, tax records (State and Federal), and bank or lending institution records, and said applicant(s) and spouse(s) waive(s) any right or causes of action that said applicant(s) or spouse(s) may have against the Nebraska Liquor Control Commission, the Nebraska State Patrol, and any other individual disclosing or releasing said information. Any documents or records for the proposed business or for any partner or stockholder that are needed in furtherance of the application investigation of any other investigation shall be supplied immediately upon demand to the Nebraska Liquor Control Commission or the Nebraska State Patrol. The undersigned understand and acknowledge that any license issued, based on the information submitted in this application, is subject to cancellation if the information contained herein is incomplete, inaccurate or fraudulent.

Individual applicants agree to supervise in person the management and operation of the business and that they will operate the business authorized by the license for themselves and not as an agent for any other person or entity. Corporate applicants agree the approved manager will superintend in person the management and operation of the business. Partnership applicants agree one partner shall superintend the management and operation of the business. All applicants agree to operate the licensed business within all applicable laws, rules, regulations, and ordinances and to cooperate fully with any authorized agent of the Nebraska Liquor Control Commission.

Must be signed in the presence of a notary public by applicant(s) and spouse(s). See guideline for required signatures



 Signature of Applicant

 Signature of Spouse

Andrew Minarik

 Print Name

 Print Name

 Signature of Applicant

 Signature of Spouse

 Print Name

 Print Name

ACKNOWLEDGEMENT

State of Nebraska
 County of Lincoln

The foregoing instrument was acknowledged before me this

26th day of February 2020 by _____
date

Andrew Minarik
name of person(s) acknowledged (individual(s) signing)



 Notary Public signature

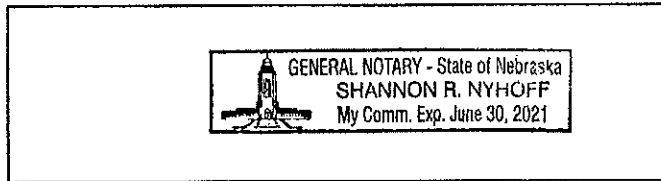

In compliance with the ADA, this application is available in other formats for persons with disabilities. A ten day advance period is required in writing to produce the alternate format.

**APPLICATION FOR LIQUOR LICENSE
LIMITED LIABILITY COMPANY (LLC)
INSERT - FORM 3b**

NEBRASKA LIQUOR CONTROL COMMISSION
301 CENTENNIAL MALL SOUTH
PO BOX 95046
LINCOLN, NE 68509-5046
PHONE: (402) 471-2571
FAX: (402) 471-2814
Website: www.lcc.nebraska.gov

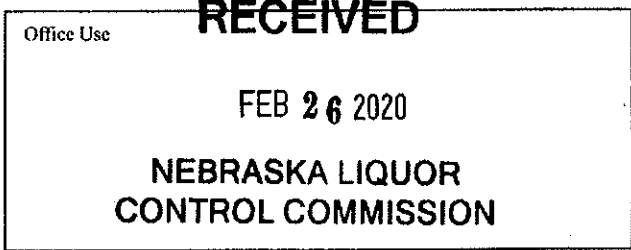

All members including spouse(s), are required to adhere to the following requirements:

- 1) All members spouse(s) must be listed
- 2) Managing/Contact member and all members holding over 25% interest and their spouse(s) (if applicable) must submit fingerprints. See Form 147 for further information, this form MUST be included with your application.
- 3) Managing/Contact member and all members holding over 25 % shares of stock and their spouse (if applicable) must sign the signature page of the Application for License form 100 (even if a spousal affidavit has been submitted)

Attach copy of Articles of Organization (must show electronic stamp or barcode receipt by Secretary of States office)

Name of Registered Agent: Andrew Minarick

Name of Limited Liability Company that will hold license as listed on the Articles of Organization
Huffman Prairie Ventures, LLC

LLC Address: Socorro 1032 North Shore Drive

City: Schuyler State: NE Zip Code: 68661

LLC Phone Number: (402) 720-6972 LLC Fax Number: N/A

Name of Managing/Contact Member

Name and information of contact member must be listed on following page

Last Name: Minarick First Name: Andrew MI: M

Home Address: 1361 County Road 4 City: North Bend

State: NE Zip Code: 68649 Home Phone Number: (402) 720-6972

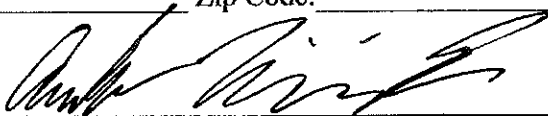

Signature of Managing/Contact Member

ACKNOWLEDGEMENT

State of Nebraska

County of Lincoln

The foregoing instrument was acknowledged before me this

26th day of February 2020

by Andrew Minarick
name of person acknowledge

Date
Shannon R. Nyhoff

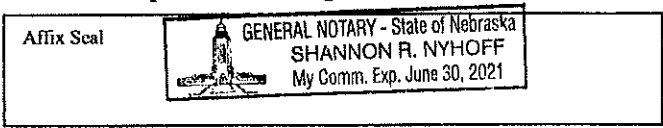

List names of all members and their spouses (even if a spousal affidavit has been submitted)

Last Name: Minarick First Name: Andrew MI: M
Social Security Number: [REDACTED] Date of Birth: 03/24/1995
Spouse Full Name (indicate N/A if single): N/A
Spouse Social Security Number: N/A Date of Birth: N/A
Percentage of member ownership 100%

Last Name: _____ First Name: _____ MI: _____
Social Security Number: _____ Date of Birth: _____
Spouse Full Name (indicate N/A if single): _____
Spouse Social Security Number: _____ Date of Birth: _____
Percentage of member ownership _____

Last Name: _____ First Name: _____ MI: _____
Social Security Number: _____ Date of Birth: _____
Spouse Full Name (indicate N/A if single): _____
Spouse Social Security Number: _____ Date of Birth: _____
Percentage of member ownership _____

Last Name: _____ First Name: _____ MI: _____
Social Security Number: _____ Date of Birth: _____
Spouse Full Name (indicate N/A if single): _____
Spouse Social Security Number: _____ Date of Birth: _____
Percentage of member ownership _____

Is the applying Limited Liability Company controlled by another corporation/company?

YES

NO

If yes, provide the following:

- 1) Name of corporation _____
- 2) Supply an organizational chart of the controlling corporation named above
- 3) Controlling corporation **MUST** be registered with the Nebraska Secretary of State, copy of articles must be submitted with application §53-126

Indicate the company's tax year with the IRS (Example January through December)

Starting Date: January Ending Date: December

Is this a Non Profit Corporation?

YES

NO

If yes, provide the Federal ID #. _____

In compliance with the ADA, this corporation insert form 3a is available in other formats for persons with disabilities.
A ten day advance period is requested in writing to produce the alternate format.

Nebraska Secretary of State

HUFFMAN PRAIRIE VENTURES, LLC

Wed Mar 4 12:02:33 2020

SOS Account Number

1911233721

Status

Active

Principal Office Address

No address on file

Registered Agent and Office Address

ANDREW M MINARICK
1381 COUNTY ROAD 4
NORTH BEND, NE 68649

Designated Office Address

SOCORRO 1032 NORTH SHORE DRIVE
SCHUYLER, NE 68661

Nature of Business

Not Available

Entity Type

Domestic LLC

Qualifying State: NE

Date Filed

Nov 15 2019

Filed Documents

Filed documents for HUFFMAN PRAIRIE VENTURES, LLC may be available for purchase and downloading by selecting the Purchase Now button. Your Nebraska.gov account will be charged the indicated amount for each item you view. If no Purchase Now button appears, please contact Secretary of State's office to request document(s).

Document	Date Filed	Price	
Certificate of Organization	Nov 15 2019	\$0.45 = 1 page(s) @ \$0.45 per page	Purchase Now

Good Standing Documents

- If you need your Certificate of Good Standing Apostilled or Authenticated for use in another country, you must contact the Nebraska Secretary of State's office directly for information and instructions. Documents obtained from this site cannot be Apostilled or Authenticated.

Online Certificate of Good Standing with Electronic Validation
\$6.50

This certificate is available for immediate viewing/printing from your desktop. A Verification ID is provided on the certificate to validate authenticity online at the Secretary of State's website.

Certificate of Good Standing - USPS Mail Delivery
\$10.00

This is a paper certificate mailed to you from the Secretary of State's office within 2-3 business days.

**MANAGER APPLICATION
INSERT - FORM 3c**

NEBRASKA LIQUOR CONTROL COMMISSION
301 CENTENNIAL MALL SOUTH
PO BOX 95046
LINCOLN, NE 68509-5046
PHONE: (402) 471-2571
FAX: (402) 471-2814
Website: www.lcc.nebraska.gov

Office Use

RECEIVED
FEB 26 2020
**NEBRASKA LIQUOR
CONTROL COMMISSION**

FORM MUST BE COMPLETELY FILLED OUT IN ORDER FOR APPLICATION TO BE PROCESSED

MANAGER MUST:

- Complete all sections of the application. Be sure it is signed by a **member or corporate officer**, corporate officer or member must be an individual on file with the Liquor Control Commission
- Fingerprints are required. See form 147 for further information, read form carefully to avoid delays in processing, this form **MUST** be included with your application.
- Provide a copy of one of the following: US birth certificate, naturalization papers or current US passport (even if you have provided this before)
- Be a registered voter in the State of Nebraska, include a copy of voter card or print document from Secretary of State website with application

Spouse who **will not** participate in the business, **spouse must:**

- Complete the Spousal Affidavit of Non Participation Insert (must be notarized). The non-participating spouse completes the top half; the manager completes the bottom half. **Be sure to complete both halves of this form.**
- Need not answer question #1 of the application

Spouse who **will** participate in the business, the **spouse must:**

- Sign the application
- Fingerprints are required. See form 147 for further information, read form carefully to avoid delays in processing, this form **MUST** be included with your application.
- Provide a copy of one of the following: birth certificate, naturalization papers or current US passport (even if you have provided this before)
- Be a registered voter in the state of Nebraska, include a copy of voter card with application
- Spousal Affidavit of Non Participation Insert **not** required

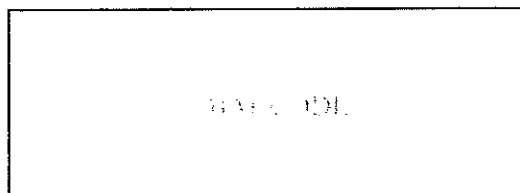

**MANAGER APPLICATION
INSERT - FORM 3c**

NEBRASKA LIQUOR CONTROL COMMISSION
301 CENTENNIAL MALL SOUTH
PO BOX 95046
LINCOLN, NE 68509-5046
PHONE: (402) 471-2571
FAX: (402) 471-2814
Website: www.lcc.nebraska.gov

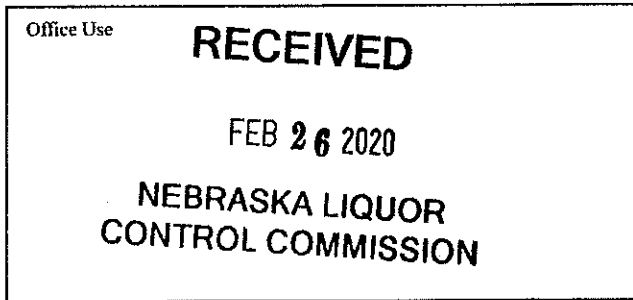

MUST BE:

- ✓ Include copy of US birth certificate, naturalization paper or current US passport
- ✓ Nebraska resident. Include copy of voter registration card or print out document from Secretary of State website
- ✓ Fingerprinted. See form 147 for further information, read form carefully to avoid delays in processing, this form MUST be included with your application
- ✓ 21 years of age or older

Corporation/LLC information

Name of Corporation/LLC: Huffman Prairie Ventures, LLC

Premise information

Liquor License Number: _____ Class Type _____ (if new application leave blank)

Premise Trade Name/DBA: Flyover Whiskey

Premise Street Address: 1614 County Road 4

City: North Bend County: Dodge Zip Code: 68649

Premise Phone Number: (402) 720-6972

Premise Email address: andrew.minarick@gmail.com

The individual whose name is listed as a corporate officer or managing member as reported on insert form 3a or 3b or listed with the Commission. To see authorized officers or members search your license information [here](#).

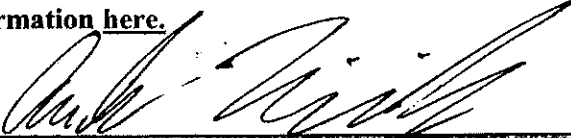

(Faxed signatures are acceptable)

Manager's information must be completed below PLEASE PRINT CLEARLY

Last Name: Minarick First Name: Andrew MI: M
 Home Address: 1361 County Road 4
 City: North Bend County: Dodge Zip Code: 68649
 Home Phone Number: (402) 720-6972
 Driver's License Number & State: H13404346 (NE)
 Social Security Number: 505-35-5528
 Date Of Birth: 03/24/1995 Place Of Birth: Fremont, NE
 Email address: andrew.minarick@gmail.com

Are you married? If yes, complete spouse's information (Even if a spousal affidavit has been submitted)

YES NO

Spouse's information

Spouses Last Name: _____ First Name: _____ MI: _____
 Social Security Number: _____
 Driver's License Number & State: _____
 Date Of Birth: _____ Place Of Birth: _____

APPLICANT & SPOUSE MUST LIST RESIDENCE(S) FOR THE PAST TEN (10) YEARS

APPLICANT SPOUSE

CITY & STATE	YEAR FROM	YEAR TO	CITY & STATE	YEAR FROM	YEAR TO
North Bend, NE	1995	2014			
Lincoln, NE	2014	2019			
Dayton, OH	2019	2020			
North Bend, NE	2020	Present			

MANAGER'S LAST TWO EMPLOYERS

YEAR FROM TO		NAME OF EMPLOYER	NAME OF SUPERVISOR	TELEPHONE NUMBER
2015	2019	Quo Vadis, LLC	Mitch Minarick	217-390-1761
2019	2019	Parker Hannifin	Paul Davis	216-896-1390

I. READ CAREFULLY. ANSWER COMPLETELY AND ACCURATELY.

Must be completed by both applicant and spouse, unless spouse has filed an affidavit of non-participation.

Has anyone who is a party to this application, or their spouse, ~~XXXX~~ been convicted of or plead guilty to any charge. Charge means any charge alleging a felony, misdemeanor, violation of a federal or state law; a violation of a local law, ordinance or resolution. List the nature of the charge, where the charge occurred and the year and month of the conviction or plea, ~~include traffic violations~~. Also list any charges pending at the time of this application. If more than one party, please list charges by each individual's name. Commission must be notified of any arrests and/or convictions that may occur after the date of signing this application.

YES NO

If yes, please explain below or attach a separate page.

Name of Applicant	Date of Conviction (mm/yyyy)	Where Convicted (City & State)	Description of Charge	Disposition

2. Have you or your spouse ever been approved or made application for a liquor license in Nebraska or any other state?

YES NO

IF YES, list the name of the premise(s):

3. Do you, as a manager, qualify under Nebraska Liquor Control Act (§53-131.01) and do you intend to supervise, in person, the management of the business?

YES NO

4. List the alcohol related training and/or experience (when and where) of the person making application.

*NLCC Training Certificate Issued: _____ Name on Certificate: _____

Applicant Name	Date (mm/yyyy)	Name of program (attach copy of course completion certificate)

*For list of NLCC Certified Training Programs see training

Experience:

Applicant Name / Job Title	Date of Employment:	Name & Location of Business:
Andrew Minarick / Engineering Student	2014-2018	University of Nebraska-Lincoln, NE
Andrew Minarick / Head of Product Development	2015-2019	FarmAfield (Lincoln NE)
Process Engineer	2019	Parker Hannifin (Lewisburg OH)

5. Have you enclosed form 147 regarding fingerprints?

YES NO

PERSONAL OATH AND CONSENT OF INVESTIGATION

The above individual(s), being first duly sworn upon oath, deposes and states that the undersigned is the applicant and/or spouse of applicant who makes the above and foregoing application that said application has been read and that the contents thereof and all statements contained therein are true. If any false statement is made in any part of this application, the applicant(s) shall be deemed guilty of perjury and subject to penalties provided by law. (Sec §53-131.01) Nebraska Liquor Control Act.

The undersigned applicant hereby consents to an investigation of his/her background including all records of every kind and description including police records, tax records (State and Federal), and bank or lending institution records, and said applicant and spouse waive any rights or causes of action that said applicant or spouse may have against the Nebraska Liquor Control Commission and any other individual disclosing or releasing said information to the Nebraska Liquor Control Commission. If spouse has **NO** interest directly or indirectly, a spousal affidavit of non-participation may be attached.

The undersigned understand and acknowledge that any license issued, based on the information submitted in this application, is subject to cancellation if the information contained herein is incomplete, inaccurate, or fraudulent.

Applicant Notification and Record Challenge: Your fingerprints will be used to check the criminal history records of the FBI. You have the opportunity to complete or challenge the accuracy of the information contained in FBI identification record. The procedures for obtaining a change, correction, or updating an FBI identification record are set forth in Title 28, CFR, 16.34.

[Handwritten Signature]

Signature of Manager Applicant

Signature of Spouse

ACKNOWLEDGEMENT

State of Nebraska

County of Lincoln

The foregoing instrument was acknowledged before me this

20th day of February 2020 by Andre Minarice

date

NAME OF PERSON BEING ACKNOWLEDGED

[Handwritten Signature]

Notary Public signature

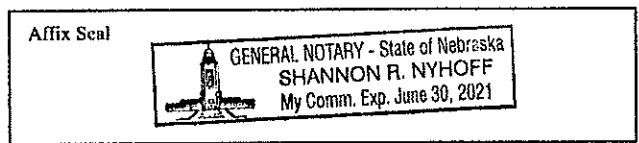

In compliance with the ADA, this application is available in other formats for persons with disabilities. A ten day advance period is required in writing to produce the alternate format.

**PRIVACY ACT STATEMENT/
SUBMISSION OF FINGERPRINTS /
PAYMENT OF FEES TO NSP-CID**

NEBRASKA LIQUOR CONTROL COMMISSION
301 CENTENNIAL MALL SOUTH
PO BOX 95046
LINCOLN, NE 68509-5046
PHONE: (402) 471-2571
FAX: (402) 471-2814
Website: www.lcc.nebraska.gov

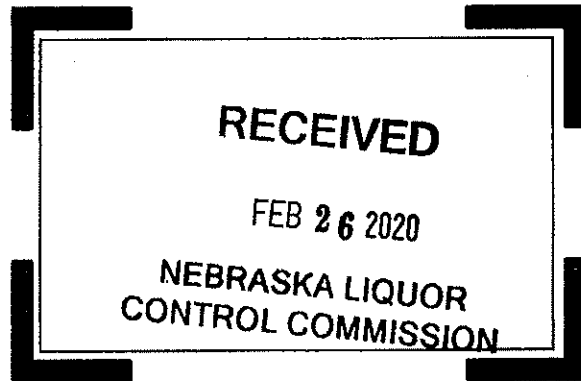

THIS FORM IS REQUIRED TO BE SIGNED BY EACH PERSON BEING FINGERPRINTED:

DIRECTIONS FOR SUBMITTING FINGERPRINTS AND FEE PAYMENTS:

- FAILURE TO FILE FINGERPRINT CARDS AND PAY THE REQUIRED FEE TO THE NEBRASKA STATE PATROL WILL DELAY THE ISSUANCE OF YOUR LIQUOR LICENSE
- Fee payment of \$45.25 per person MUST be made DIRECTLY to the Nebraska State Patrol;
It is recommended to make payment through the NSP PayPort online system at www.ne.gov/go/nsp
Or a check made payable to NSP can be mailed directly to the following address:
Please indicate on your payment who the payment is for (the name of the person being fingerprinted) and the payment is for a Liquor License
The Nebraska State Patrol – CID Division
3800 NW 12th Street
Lincoln, NE 68521
- Fingerprints taken at NSP LIVESCAN locations will be forwarded to NSP – CID
Applicant(s) will not have cards to include with license application.
- Fingerprints taken at local law enforcement offices may be released to the applicants;
Fingerprint cards should be submitted with the application.

Applicant Notification and Record Challenge: *Your fingerprints will be used to check the criminal history records of the FBI. You have the opportunity to complete or challenge the accuracy of the information contained in FBI identification record. The procedures for obtaining a change, correction, or updating a FBI identification record are set forth in Title 28, CFR, 16.34.*

Trade Name: Flyover Whiskey
Name of Person Bring Fingerprinted: Andrew Minarick
Date of Birth: 03/24/95 Last 4 SSN: 5528 Date fingerprints were taken: 2/19/20
Location where fingerprints were taken: Nebraska State Patrol CID

How was payment made to NSP?

NSP PAYPORT CASH CHECK SENT TO NSP CK # _____

My fingerprints are already on file with the commission – fingerprints completed for a previous application less than 2 years ago? YES

A handwritten signature in black ink, appearing to read "Andrew Minarick", written over a horizontal line.

SIGNATURE REQUIRED OF PERSON BEING FINGERPRINTED

Important Message:
 If you have recently moved, please use the Polling Place feature. Locate Your Polling Place with the street and city address of your new/current residence.

[HOME](#)

REGISTRATION INFORMATION

[POLLING PLACE](#)

[PROVISIONAL BALLOT](#)

[ABSENTEE BALLOT](#)

Select Language ▼

Registrant Search Information

Registrant Detail

Name: Andrew Michael Minarick
Party: Republican
Polling Place: UN/CT/RG/PV South 032
 VFW Club
 742 Main St
 North Bend, NE 68649

Districts

DISTRICT NAME	DISTRICT TYPE
Metro Com College Dist 1	Community College District
State Board of Education Dist3	State Board of Education
Omaha Public Power SubD 7	Public Power District
Nebraska PPD SubD 9	Public Power District
County Judge Dist 6	Judge of County Court Dist.
District Judge, Dist 6	Judge of District Court Dist.
Supreme Court Judge Dist 3	Judge of Supreme Court Dist.
U.S. Congressional District 1	U.S. Congressional District
Appeals Court Judge Dist 3	Judge of Appeals Court Dist.
Legislative District 15	Legislative District
Board of Regents District 3	Board of Regents
ESU 2 District 3	ESU District
Lower Elkhorn NRD SubD 7	Natural Resources District
Lower Elkhorn NRD At Large	Natural Resources District
North Bend Central Public Schs	School District
Union Township	Township Board
County Supervisor Dist 4	County Board (Commiss./Superv)
PSC District 4	Public Service Comm District

[Registration Information](#) [Voter View Mobile](#) [Polling Place](#) [Provisional Ballot](#) [Absentee Ballot](#)

© Copyright 2020 ESSVR, LLC. All rights reserved.
 © Voter View 3.3.1480.10

Commercial Lease Agreement

This Commercial Lease Agreement ("Lease") is made and effective 3/29/20 by and between Minarick Family Properties LLC and Hullman Private Ventures LLC ("Tenant").

Landlord is the owner of land and improvements commonly known and numbered as 1614 County Road 4, North Bend, NE (Address). The 'Leased Premises' refers to the detached general purpose/storage building.

Landlord desires to lease the Leased Premises to Tenant, and Tenant desires to lease the Leased Premises from Landlord for the term, at the rental and upon the covenants, conditions and provisions herein set forth.

THEREFORE, in consideration of the mutual promises herein, contained and other good and valuable consideration, it is agreed:

1. Term. Landlord hereby leases the Leased Premises to Tenant, and Tenant hereby leases the same from Landlord, for an "Initial Term" beginning 5/1/2019 and ending 4/1/2030. On 3/1/2020 Tenant shall have possession of the lease premises. The Tenant will have the option to renew the lease at the end of each lease term.
2. Rent. Tenant shall pay to Landlord a monthly rent during the initial term and during the renewal period lease of \$ 50.00 per month.
3. Use. Notwithstanding the forgoing, Tenant shall not use the Leased Premises for any unauthorized purposes.
4. Sublease and Assignment. Tenant shall not sublease all or any part of the Leased Premises, or assign this Lease in whole or in part without Landlord's effective written consent.
5. Utilities. All charges for sewer, gas, electricity, telephone and other services and utilities used by Tenant on the Leased Premises during the term of this Lease will be included in the monthly rent.
6. Entry. Tenant will control access to the locks and security measures for the Leased Premises. Landlord shall have the right to inspect the Leased Premises at reasonable hours with the accompaniment of the Tenant, provided Landlord shall not thereby unreasonably interfere with Tenant's business on the Leased Premises.
7. Leased Premises Rules. Tenant will comply with the rules of the Leased Premises adopted and altered by Landlord from time to time and will cause all of its agents, employees, invitees and visitors to do so; all changes to such rules will be sent by Landlord to Tenant in writing.

IN WITNESS WHEREOF, the parties have executed this Lease on 3/29/20.

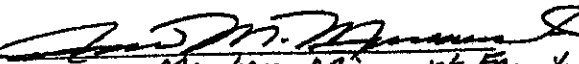
Landlord Member, Minarick Family Properties LLC

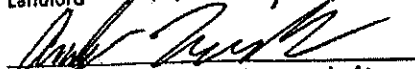
Tenant Member - Hullman Private Ventures, LLC

RECEIVED

FEB 26 2020

NEBRASKA LIQUOR
CONTROL COMMISSION

Class Z Micro-Distillery Business Plan

Company

Huffman Prairie Ventures, LLC

DBA Flyover Whiskey

Premises Address:

1614 County Road 4

North Bend, NE 68649

Owner

Andrew Minarick

1361 County Road 4

North Bend, NE 68649

andrew.minarick@gmail.com

(402) 720-6972

Company Structure

Flyover Whiskey will be operating (DBA) under the Limited Liability Company of Huffman Prairie Ventures, LLC. Huffman Prairie Ventures, LLC is a sole-member LLC with Andrew Minarick as the sole owner and operator.

Overview

Flyover Whiskey will turn Nebraska Grain Farmers' corn into custom, high-quality whiskey products.

While many distillery operations focus on bulk production and large distribution channels, Flyover Whiskey will focus on a small, niche approach. My company will allow farmers to send in some of their grain, which will then be turned into a mash, distilled, and bottled in custom-labeled bottles that list the region and operation that provided the grain for the mash ingredients. We will then ship these whiskey products directly to the consumer, providing an easy, cheap way to enjoy 'farm-grown' products.

Problem

Farmers are often accustomed to watching many of their products become commoditized, resulting in a disconnect from the tangible nature of their profession, both for themselves and consumers across the state. There are few ways in which farmers can enjoy the fruits of their labor in real, novel ways.

Furthermore, consumers desire to know where their food-related products come from. For many companies, it is not economically feasible to cater to this desire as the food-related supply chains increase in complexity as these operations seek to reach economies of scale.

Opportunity

There is a growing trend among consumers that prefer Farm-to-Fork products. Consumers want to know where their food and drink comes from, but complex supply chains make tracing the origin of these products difficult. There is a growing desire for these consumers to see the origin and story behind what they eat and drink. As the 'Farm-to-Fork' trend continues, Flyover Whiskey hopes to use that driver to develop a similar 'Farm-to-Glass' model.

Customer Segments, Value Propositions, Channels

Customer Segment #1 (Main): Grain Farmers

Value Proposition:

- Pride in Custom Whiskey from Farming Operation, Affordable Pricing, Ease of Use

Channels/Marketing:

- Personal Contacts, Social Media, Farm-Related Advertising

Customer Segment #2 (Secondary): Consumers wanting to connect with local farms

Value Proposition:

- Access to products sourced from friends or farms they know

Channels/Marketing:

- Personal Contacts, Social Media

Revenue Structure

Flyover Whiskey will charge a flat fee of \$250 per order that will include shipping and processing. This will yield eight, 750 mL bottles of 35% corn whiskey.

Whiskey Production Process

My operation will source corn directly from farmers, with sugar and yeast procured from wholesalers. The corn will be washed and sanitized using a hot water bath and then cooked in a separate warm water solution to break down starches and prepare for fermentation. The solution will be separated from any unwanted residue and mixed with sugar and yeast. The solution will be added to sanitized 5-gallon plastic buckets with airtight seals, with an airlock installed to facilitate the anaerobic fermentation process (approximately 5-14 days). Once the fermentation process is over, the solution will be strained and transferred to an 8 gallon, stainless-steel still. Using a column still and condenser, the liquid will be heated from 140-160 degrees Fahrenheit until all low boiling point distillate foreshot (i.e. methanol) is removed. The temperature will then be raised to 173 degrees. From the 173 to 185 degree range we will make our 'head' cut. As our temperature is raised to 205 degrees, we will make subsequent cuts, all at approximately 80% alcohol by volume. Once we have collected each cut (measured using graduated flask) and are finished with our distillation process, we will then dilute the cuts to 40% alcohol by volume, measuring alcohol content with a hydrometer, and storing solution in sanitized storage containers. We will then begin the aging process with charred oak. Once the aging process is completed, we will then measure alcohol content to maintain 35-40% alcohol content and strain the aged whiskey into 750mL glass bottles. We will ensure proper labeling and send out to be shipped direct to consumer (in Nebraska).

Team and Background

Andrew holds a degree in Biological Systems Engineering, with minors in Agribusiness Entrepreneurship and Biomedical Engineering (University of Nebraska-Lincoln). He was born and raised surrounded by agriculture in North Bend, NE and has experience founding and growing a software startup company, where he lead product development teams to create a microfinance platform. Andrew has also spent time working as a Process Engineer for a Fortune 250 company where he helped develop, fund, and implement new technology in the manufacturing sector.

During his undergraduate studies, Andrew has taken several years of General Chemistry, Biology, Organic Chemistry, and Biochemistry, all of which consisted of rigorous coursework and hands on laboratory experience, including solution purification via distillation methods. He has extensive experience managing data, creating accounting systems, and working with regulatory bodies to maintain compliance.

He is confident his background and experience will help him operate a micro-distillery in a safe and effective manner.

Financial Projections

This business is mainly intended to be part-time hobby with low levels of production that generate small amounts of side income. Below is a simple overview of projected production, sales, expenses, and revenues.

NOTE: Numbers are estimates and 'Other' expenses expected to be updated.

Key Metrics

Pro Forma Income

Wholesale Orders	\$	25,000	\$	25,000	\$	30,000	\$	30,000	\$	30,000
Operating Expenses										
Lease Agreement	\$	50.00	\$	50.00	\$	50.00	\$	50.00	\$	50.00
Process Patents/Licenses	\$	800.00	\$	200.00	\$	-	\$	-	\$	-
IP	\$	250.00	\$	50.00	\$	-	\$	-	\$	-
Plant Equipment	\$	150.00	\$	50.00	\$	-	\$	-	\$	-
Production Expenses										
Raw Material Ingredients	\$	425.00	\$	75.00	\$	85.20	\$	95.20	\$	85.20
Plant Overhead	\$	500.00	\$	100.00	\$	120.00	\$	120.00	\$	120.00
Utilities	\$	400.00	\$	80.00	\$	90.00	\$	90.00	\$	90.00
Labor	\$	300.00	\$	50.00	\$	60.00	\$	60.00	\$	60.00
Labeling and Shipping Expenses										
Labeling	\$	100.00	\$	20.00	\$	24.00	\$	24.00	\$	24.00
Production	\$	210.00	\$	35.00	\$	42.00	\$	42.00	\$	42.00
Shipping/Freight	\$	2,400.00	\$	400.00	\$	480.00	\$	480.00	\$	480.00
Other										
Marketing	\$	650.00	\$	25.00	\$	25.00	\$	25.00	\$	25.00
Rent	\$	120.00	\$	10.00	\$	10.00	\$	10.00	\$	10.00
Taxes		TBD		TBD		TBD		TBD		TBD
Net Operating Income (Loss)	\$	6,440	\$	16,214	\$	20,581	\$	20,581	\$	20,581

CERTIFICATE OF ORGANIZATION

OF

Huffman Prairie Ventures, LLC

A Nebraska Limited Liability Company

ARTICLE I - NAME

The name of the Limited Liability Company is:
Huffman Prairie Ventures, LLC (the "Company")

ARTICLE II - DESIGNATED OFFICE

The Company's designated office in Nebraska is:
Socorro 1032 North Shore Drive, Schuyler, NE 68661

ARTICLE III - REGISTERED AGENT

The name of the registered agent of the Company is:
Andrew Minarick, 1361 County Road 4, North Bend, NE 68649

IN WITNESS WHEREOF, this Certificate of Organization has been executed by the undersigned Organizer, effective as of the 13th day of November, 2019.



Andrew Minarick, Organizer

Date of this notice: 01-02-2020

Employer Identification Number:
84-4119883

Form: SS-4

Number of this notice: CP 575 G

HUFFMAN PRAIRIE VENTURES
ANDREW MINARICK SOLE MBR
1361 COUNTY ROAD 4
NORTH BEND, NE 68649

For assistance you may call us at:
1-800-829-4933

IF YOU WRITE, ATTACH THE
STUB AT THE END OF THIS NOTICE.

WE ASSIGNED YOU AN EMPLOYER IDENTIFICATION NUMBER

Thank you for applying for an Employer Identification Number (EIN). We assigned you EIN 84-4119883. This EIN will identify you, your business accounts, tax returns, and documents, even if you have no employees. Please keep this notice in your permanent records.

When filing tax documents, payments, and related correspondence, it is very important that you use your EIN and complete name and address exactly as shown above. Any variation may cause a delay in processing, result in incorrect information in your account, or even cause you to be assigned more than one EIN. If the information is not correct as shown above, please make the correction using the attached tear off stub and return it to us.

A limited liability company (LLC) may file Form 8832, *Entity Classification Election*, and elect to be classified as an association taxable as a corporation. If the LLC is eligible to be treated as a corporation that meets certain tests and it will be electing S corporation status, it must timely file Form 2553, *Election by a Small Business Corporation*. The LLC will be treated as a corporation as of the effective date of the S corporation election and does not need to file Form 8832.

To obtain tax forms and publications, including those referenced in this notice, visit our Web site at www.irs.gov. If you do not have access to the Internet, call 1-800-829-3676 (TTY/TDD 1-800-829-4059) or visit your local IRS office.

IMPORTANT REMINDERS:

- * Keep a copy of this notice in your permanent records. **This notice is issued only one time and the IRS will not be able to generate a duplicate copy for you.** You may give a copy of this document to anyone asking for proof of your EIN.
- * Use this EIN and your name exactly as they appear at the top of this notice on all your federal tax forms.
- * Refer to this EIN on your tax-related correspondence and documents.

If you have questions about your EIN, you can call us at the phone number or write to us at the address shown at the top of this notice. If you write, please tear off the stub at the bottom of this notice and send it along with your letter. If you do not need to write us, do not complete and return the stub.

Your name control associated with this EIN is HUFF. You will need to provide this information, along with your EIN, if you file your returns electronically.

Thank you for your cooperation.

APPLICATION FOR REGISTRATION OF TRADE NAME

Robert B. Eynen, Secretary of State
P.O. Box 94608, Lincoln, NE 68509
(402) 471-4079
www.sos.ne.gov

Submit in Duplicate

PUBLICATION REQUIREMENT: Neb. Rev. Stat. §87-219 "Every duplicate of the registration of a trade name shall be published by the applicant once in a newspaper of general circulation published in the city or village where the business is to be located, or, if there is no newspaper in the city or village, in some newspaper of general circulation in the county. Proof of such publication shall be filed in the office of the Secretary of State within forty-five days from the date of registration in the office of the Secretary of State. **If proof of publication is not filed with the Secretary of State within the forty-five days, the registration shall be canceled by the Secretary of State.**"

Trade Name Flyover Whiskey

Name of Applicant Huffman Prairie Ventures, LLC

Address Socorro 1032 North Shore Drive, Schuyler Nebraska 68661
street address city state zip

Applicant is Individual Corporation Limited Liability Company Partnership
 Limited Liability Partnership Limited Partnership Other (specify) _____

If other than an Individual, state under whose laws entity was formed: Nebraska

Date of first use of name in Nebraska 2/10/2020

General nature of business Flyover Whiskey will operate as a micro-distillery for small-scale whiskey products. (License Pending)

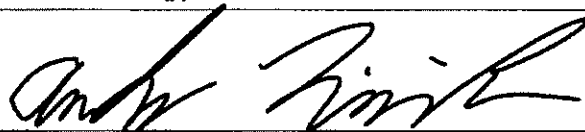

Signature of Applicant or Legal Representative

Please Note:

Registration of a trade name with the State of Nebraska does not guarantee that a similar name has not been registered nationally with the U.S. Patent and Trademark Office. To check national availability go to: <http://www.uspto.gov/main/trademarks.htm>

Make check payable to: Nebraska Secretary of State

FILING FEE: \$100.00

Registration Expires 10 years from date of filing

**SEE SECOND PAGE FOR INSTRUCTIONS TO
PUBLISH LEGAL NOTICE OF A TRADE NAME**